

LED Connectors

EB3400

Lowest Profile in the Industry!

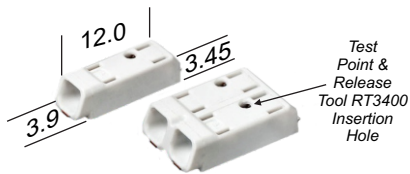

mm shown

- Extremely Low Profile — 3.45mm
- **Minimizes Shadowing Effect**
- 1 and 2 Pole Versions Available
- 4mm Centerline Spacing
- Tape and Reel Packaging
- ◆ 1 Pole - 600V, 6A, 18-24 AWG
- ◆ 2 Pole - 250V, 6A, 18-24 AWG

LED-SMD Connector Release Tools



EB3400 BLANK

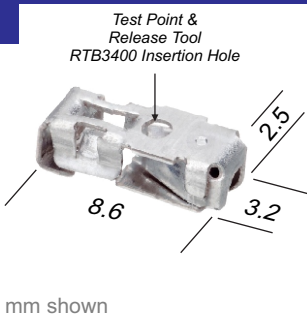
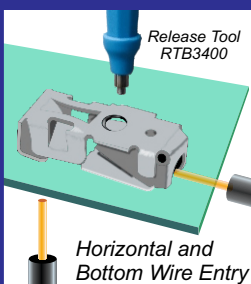

mm shown

- Extremely Low Profile — 2.5mm
- Minimizes Shadowing Effect
- Horizontal or Bottom Vertical Wire Entry
- Available 1 Pole Only
- Suggested 4mm Centerline Spacing*
- Tape and Reel Packaging
- ◆ 1 Pole - 320V, 6A, 20-24 AWG

* Depending on use

EB5400

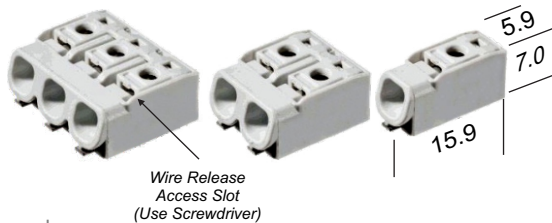

mm shown

- Can Handle 12 AWG
- 1, 2 and 3 Pole Versions Available
- Standard Screwdriver to Release Wire
- 6mm Centerline Spacing
- Tape and Reel Packaging
- ◆ 1 Pole - 600V, 16A, 12-20 AWG
- ◆ 2 & 3 Poles - 250V, 16A, 12-20 AWG

LED-SMD Connection Jumpers - 1 Pole & 2 Pole

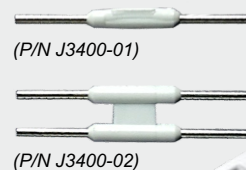

EB3100

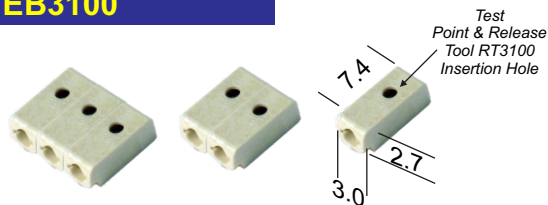

mm shown

- Extremely Low Profile — 2.7mm
- Minimizes Shadowing Effect
- 1, 2 and 3 Pole Versions Available
- 3.0mm Centerline Spacing
- Tape and Reel Packaging
- ◆ 150V, 3A, 22-26 AWG

EB430 & EB401

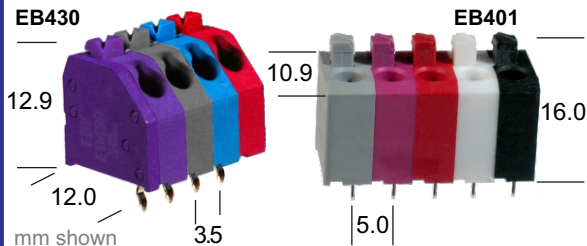

mm shown

- Available 2 - 24 Poles
- Lever-Actuated Field Wiring
- Optional Color Coding Prevents Miswiring
- ◆ **EB430:** 3.5mm Centerline 300V, 6A, 16-22 AWG
- ◆ **EB401:** 5.0mm Centerline 300V, 10A, 16-20 AWG



CONTACT US FOR SAMPLES



Corporate Headquarters USA
EBY Electro, Inc.
210 Express Street
Plainview, NY 11803-2423 USA

The Connection Experts Since 1945
www.EBYelectro.com

Call Us — 9AM to 5PM EST
Tel: (516) 576-7777
Fax: (516) 576-1414
Email: info@EBYelectro.com